



PRODUCTS

Products: S-Series 032



MODEL	LENGTH	WIDTH	HEIGHT	DRAWINGS	
				(.pdf)	(.dwg)
032	4.380"	3.250"	1.410"		
Click to view circuit board diagram (330 , 430)					

FEATURES

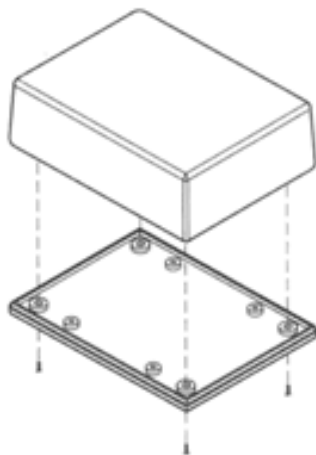

- Two-piece standard design
- Circuit board mounting bosses
- Wall mount option (select models)
- Assembly with four screws
- Customization available
 - two insert areas/I-Plates ([top and bottom](#))
 - [machining](#)
 - [pad printing](#)

COLORS



Black



Almond



Gray

[Custom Colors Also Available](#)

[RETURN TO TOP](#)

ACCESSORIES (Click an accessory for compatible models and part numbers)

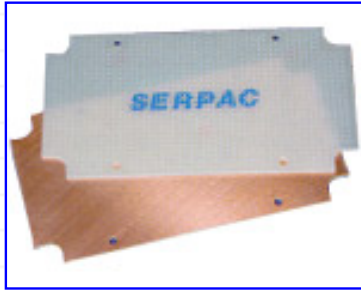

**Grid and Clad Prototyping Boards
(P/N 330, 430)**

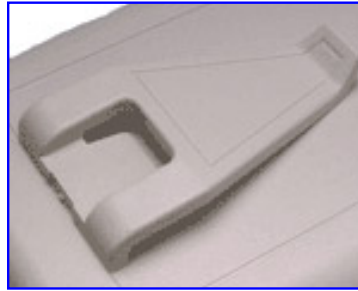

Pocket Clip



Key Holder

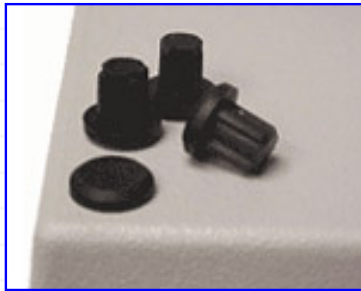

Non-Skid Feet (P/N 51)

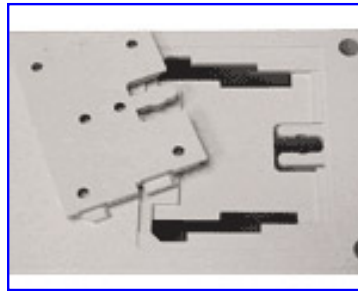

Wall Mount

[RETURN TO TOP](#)

[Home](#) | [About SERPAC](#) | [Products](#) | [Accessories](#) | [Customizations](#) | [Distributors](#) | [Buy Now!](#) | [Contact Us](#)

PRODUCTS: [A-Series](#) | [C-Series](#) | [CA-Series](#) | [CH-Series](#) | [G-Series](#) | [H-Series](#) | [M-Series](#) | [R-Series](#) | [S-Series](#) | [SL-Series](#)

© 2004, SERPAC Electronic Enclosures. All Rights Reserved